

SR-Line Industry monitors



USER MAUAL

Booth: 05.12.2022

Reproductions of any kind, even as excerpts, require the written permission of SR System-Elektronik GmbH.

ATTENTION: This document will not be withdrawn when a new edition is published, all previous editions will lose their validity.

Copyright © 2022 SRLine

Table of contents

Electrostatic sensitive assemblies	4
General	5
Introduction	6
Definitions, abbreviations	
Definitions	7
Abbreviations	7
Safety instructions	8
Commissioning the TFT monitor	9
Notes on compliance with the EMC directive (CE mark)	10
EMV	10
Model variants	11
Auto signal detection	12
Features	12
VESA mounting	12
Environmental conditions	12
Operation OSD	13
Functions and keys	13
Hotkeys	13
OSD Status (external LED's)	13
OSD Menu Overview	
Menu image	14
Menü Farbe	15
Menü OSD Einstellungen	16
Audio menu	16
Operation and repairs	18
Cleaning	19
Correct disposal	20
EMV and device safety	21
Appendix	22
Pin assignment VGA	22
DVI D24P	23
AC supply	24
DC- Plug 12 / 24 V	24
Grounding bolt	24

Modified Chapter / Page	Output stand	Reason for change
	05.12.2022	Creation of this document

Electrostatic sensitive modules!

Electronic components can be damaged or destroyed by electrostatic discharges. This does not necessarily lead to a failure of the module, it can also result in malfunctions! The following instructions must therefore be observed:

- Before working on the open unit, any charge on the body must be discharged by touching the grounded housing parts.
- The same applies, of course, to any (protective-insulated) tools to be used. This must also be discharged on a grounded object.
- If you remove or add modules from the system, the device must always be switched off or disconnected from the supply voltage.
- You should always touch modules only at the edge. Touching the conductor tracks and connection pins must be avoided at all costs.

General

The operating manual is intended to assist you with the assembly, installation and operation of the flat panel monitor. Please read through the manual completely once, as information relating to several chapters is only reproduced once. Keep the manual in a safe place. Follow all instructions and warnings marked on the product itself. Do not use any liquid or corrosive cleaning agents. Use a damp, lint-free cloth for cleaning. Never operate the device near water.

Never place the device on an unstable surface. All slots and openings on the bottom and back of the device are used for ventilation to adequately protect the device from overheating. These ventilation slots must never be covered. The unit must never be placed near or on a radiator or other heat source. The unit must always be connected to a power supply according to the label on the back of the housing. Do not insert any objects through the ventilation slots. Do not spill liquids on the unit. Leave all repairs to qualified personnel.

Do not expose the unit to direct sunlight.

SR assumes no warranty, legal responsibility or any liability for consequences resulting from incorrect information. Changes to the scope of performance and technical data can be made at any time and without special notification.

Introduction

This LCD display functions as a video-compatible color display.

The monitor is used to drive digital TFT displays with resolutions from 640 x 480 up to 1920 x 1080 dots directly with the standard video signals of PCs and workstations.

A special graphics card is not required. The image signal is supplied via a normal monitor cable.

Video modes with lower resolutions than the TFT resolution can be expanded as required, thus using the full display area of the display. By using high-quality filters, the image content is preserved. Since the video signals from PCs and workstations are not subject to any standardization in terms of timing, the image position can be adjusted in all parameters for special variants. All necessary adjustments are made via an easy-to-use OSM menu (on-screen manager) and only have to be made once; the selected parameters are saved.

The monitor is supplied via the integrated wide-range power supply or via an external voltage source. All other voltages necessary for the operation of the board and the display are generated on board.

The TFT monitor has the following features:

- robust, industrial design
- optionally equipped with touch screen
- EMC-compliant design for increased noise immunity and reduced interference radiation, CE mark and declaration of conformity for tested variants
- compatible to industrial standard

Definition, abbreviations

Definition

Abbreviations

OSD	O n S creen D isplay
MHz	Number of oscillation processes in millions of oscillations per second
KHz	Number of oscillation processes in thousands of oscillations per second
Hz	Number of oscillation processes in oscillations per second
H-Sync	Indicates the start of transmission of a new line. Serves for synchronization between an image source and a receiver.
V-Sync	Indicates the start of transmission of a new line. Serves for synchronization between an image source and a receiver.



European Union Declaration of Conformity



Direct current DC



Alternating current AC

Safety instructions



The TFT monitor is designed for use in industrial and commercial areas. The person who installs the device is responsible for safety, compliance with occupational safety and accident prevention regulations, and all other legal requirements.

Commissioning, setup and repair work may therefore only be carried out by professionally qualified personnel. The following safety instructions must be observed:

- When opening the rear panel of the unit, live parts may be exposed. The monitor unit must therefore first be switched off and disconnected from the mains by taking appropriate measures.
- If it is unavoidable to operate the unit in the open state during setup and repair work, special care must be taken. No conversions may be carried out in this state. It cannot be ruled out that this will cause short circuits which will result in damage to various components.
- Due to the manufacturing process, it cannot be ruled out that sharp corners and edges may protrude from printed circuit boards and sheet metal parts. Please handle with care to avoid injuries.
- When the device is open, make sure that no electrically conductive foreign bodies, such as metal chips and screws, can get into the device, as this can cause short circuits with serious consequences.

This monitor can only be operated in an installation system. It must be adequately protected against the following external influences: **(installation precautions)**

- Water, humidity above 85%.
- Touch of the user (except screen front)
- penetration of metal parts (smaller than 4mm)
- flammable substances and gases - heat above +50°C

Putting the TFT monitor into operation

Unpack device

The device is delivered in a sturdy cardboard box. The device is fixed in place and protected from damage during transport by the tensioned Swing foil. Keep all parts for the time being in order to have suitable transport packaging in case of a necessary return.

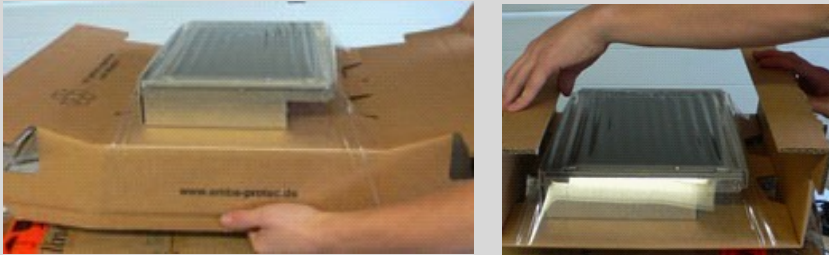

Check the device and the accessories supplied for transport damage. If damage is visible on the device, it must not be put into operation, as safety could be impaired. Contact the sender immediately!

Check the scope of delivery against the delivery bill.

Installation of the device unit

The device must not be exposed to excessive cold, heat, moisture or dirt. The ambient conditions specified in the "Technical data" must be observed to maintain operational safety!

Before attaching the device to a VESA mount, check whether the maximum permissible weight for the mount is observed. This is specified by the manufacturer.

When mounting the device, make sure that sufficient ventilation of the device unit is ensured.

Make sure that there is sufficient space for the connections and that no sharp edges or corners protrude in this area. This could result in damage to the connection cables and impair the function and safety.

Threaded bolts may be tightened to a maximum of 2.6 Nm!

Notes on compliance with the EMC Directive (CE mark)

Within the EU, laws require compliance with uniform limit values for interference radiation and interference immunity. The TFT monitor is built in such a way that these limits are complied with. It is therefore provided with the CE mark and a declaration of conformity. Outside the EU, the respective national regulations must be observed.

Devices that are connected to the TFT monitor must also comply with the corresponding limit values. This is the only way to ensure that the entire system complies with the legal regulations. Make sure that all devices have an appropriate test mark or manufacturer's declaration.

The connection to the connected devices must be made via shielded cables. Cables with foil shielding are less suitable than cables with braided shielding and a high degree of coverage. The connector housing must have an all-round connection with the cable shield.

EMV

- This is a Class A device (industrial use). It may cause radio interference in residential areas. In this case, the operator may be required to implement appropriate measures and to pay for them.
- The present device serves as an installation component in an industrial application. The operator of the overall system is required to comply with the electromagnetic compatibility according to the EMV law.

Model variants

Part number - Key for monitors of the

www.sr-line.com

Product line	Product division	Diagonale	Version	Varianten-Code 1	Varianten-Code 2	Varianten-Code ...
R-	FLAT	15 /	8 -	A	B	...
R = 19"-Front OM = Chassis M = Metall P = PCAP	Flat = Industrie LCD IPC = Industrie PC Kit = LCD-Kit Flat/IPC = Pultrount	Größe [Zoll]				

Application:

Product line, product division, diagonal and version together result in the detailed designation of the product group. The variant codes define the exact equipment of the monitors, so that a meaningful article number is available for each individual monitor. The variant codes are added to the product group designation one after the other as required (following the sequence of the variant table). Only one variant may be used from each area. Therefore, only the variants with which the respective monitor is equipped are listed in the result.

3= Vorgänger 7
7=High Level
8=Low Level
4=Multi
5=microPult.
6=flaches Gehäuse
U=Unterputz
W=WideScreen
O=Outdoor
FHD Full HD 1080 HD 1366x768

Description	Addition	Variant code
Mini Frontblende		M
Edelstahl	V2A V4A (Salzwasser, etc.)	A A4
RAL 7032	kieselgrau	G
RAL 7035	lichtgrau	W
RAL 9010	reinweiß	F
RAL 7047 Fein matt	telegrau 4	C
(RAL 9006)	weissaluminium / eloxiert	E
RAL 9005	tiefschwarz	S
resistiver Touch	USB seriell	N R
kapazitiv Touch	USB seriell	L K
SAW Touch (Intelli)	USB seriell	h H
Accu Touch	USB seriell	q Q
Bedienelemente vorne	(seitlich bei M-FLAT)	B
24V DC 230V AC(12 V extern)	(12 V p) (abweichend von Standard)	P Y
Video BAS / FBAS	BNC (Cinch,S-Video)	V
DisplayPort (HDMI)	(Achtung: früher DVI)	D (d)
TTL-Video	CGA, EGA, MDA	T
XGA für 8" / 12"	Auflösung 1024 x 768	X
Unterputzdose	Wandebau (nur 19")	U

R-FLAT 15/8-B (Bedienelemente vorne)
R-FLAT 15/8-ALP (Edelstahl, Touch kap. USB, 24 V DC)
R-FLAT 15/10024 (Kundenvariante, Kundennr.=10024) (weitere Kundenvarianten "a,b,...": 10024a..)

VESA-DPMS / Behavior without video signal

HSYNC	VSYNV	Mode
ON	ON	Normal
OFF	ON	Standby
ON	OFF	Suspend
OFF	OFF	Power Off

The monitor signals a missing video signal in the switched-on state via an OSD message (OSM menu, No Sync). The LED of the OSD changes to red or flashes.

Auto signal detection

This function automatically detects the connected video input signal. The monitor has a VGA input/DVI and optional display port or HDMI input. The controller starts with VGA, then DVI, HDMI, DP. If the signals become active later, the portscan be within the search sequence. No priority is set here, first signal detected ! it stays until it becomes inactive. Only after that the portscan is done again. If no signal is connected or the video signal is lost (connection is disconnected), the monitor behaves as described under VESA- DPM S. This mode can only be restored by turning the power off. As long as the monitor is not switched to the power suspend mode, the last detected video source returns when the monitor is switched on again (image is displayed again).

Characteristics

Supports PC signals from 640x480 to 1920x1200 (depending on LCD display) with 60 Hz V-Sync.

DOS, VGA, SVGA, XGA, WUXGA, SXGA, UXGA (abhängig von der Panel-Spec.)

H-Sync: 30 KHz ~ 80 kHz

V Sync: 56 Hz~ 75 Hz

VESA- mounting

Mounting screws M4 x 75 mm (length = max. 10 mm!); M8 for larger devices.

Environmental conditions

Operating temperature: 0° to +50° C







Storage temperature: -20° to +60° C

Humidity: 85% (non-condensing)

Service OSD

All settings are made via the **OnScreenDisplay** (OSD).

Functions and keys

Item		Description
Menu		Enter OSD main menu Leave sub menu Leave OSD main menu
Select		Enter submenu Select "feature"
Down/Minus		Navigate down in menu Decrease value
Up/Plus		Navigate up in menu Increase value
Power		Turn power on/off
Reset		Reset board to default values
2 color LED		Red/Blue

Hotkeys

DOWN	Brightness / Volume
UP	Auto Adjustment
SELECT	VGA, DVI Change
MENU	OSD Menu / Exit

OSD Status (external LED`s)

condition	Description
Amber flashing	Stand by
Blue flashing	Searching display mode (source)
Blue permanent	Ok
LED off	Power off (press power button 2 sec)

OSD Menu Overview

To activate the OSD, press the "Menu" key

Menu „Picture“

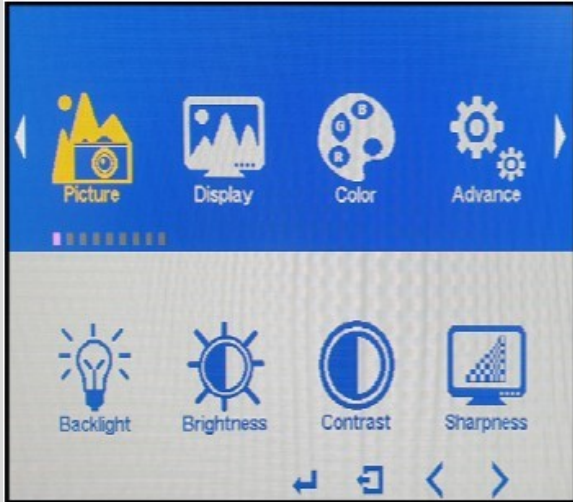

OSD Menu	Description
Backlight	Setting the BLU (backlight) level (0~100)
Brightness	Setting the LCD Brightness (0~100) the LCD Brightness (0~100)
Contrast	Adjust the image contrast (0~100)
Image sharpness	Setting the image sharpness (0 ~ 4)

Menu „Display“

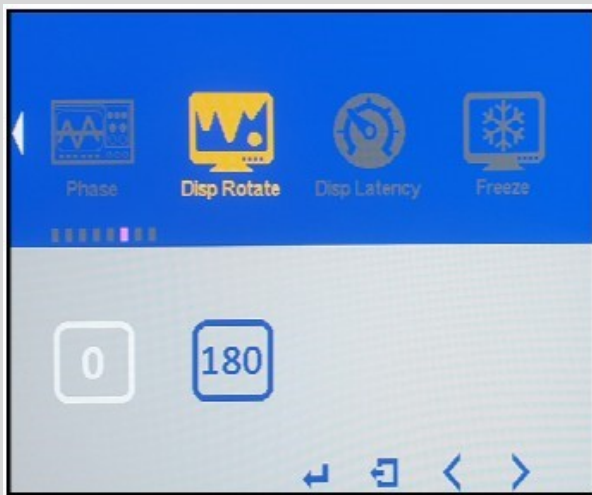

OSD Menü

Disp. Rotate

Description

Screen can be rotated up to 180°.

Menu „Color“

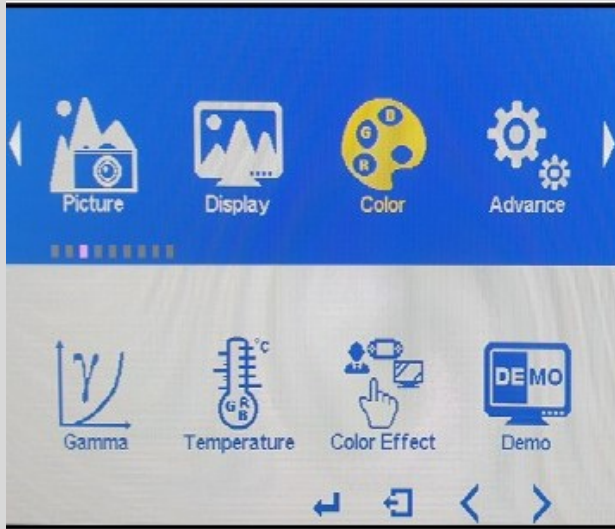

OSD Menu	Description
Gamma	Select the image gamma value (Off / 1.8 / 2.0 / 2.2 / 2.4)
Temperatur	Select color temperature (9300 / 7500 / 6500 / 5800 / sRGB / User)
Color effect	Select the color mode (Standard / Game / Movie / Photo / Vivid / User).
Demo	The user can test the values of the color menu in demo mode.
Shade	Setting the digital color value (0~100)
Saturation	Setting the digital color value (0~100)

Menu „Advance“

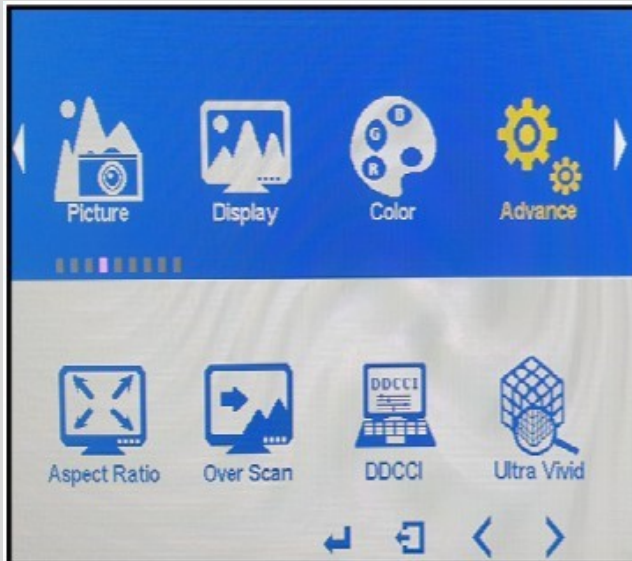

OSD Menu	Description
Aspect ratio	Set display ratio (full screen / 16:9 / 4:3 / 5:4 / 1:1 / User)
Over Scan	Display Over Scan Function (only HDMI Video Input)
DDCI	DDCI function enable (On / Off)
Ultra Vivid	Ultra Vivid Level (Off / Low / Middle / High)

Menu „Audio“

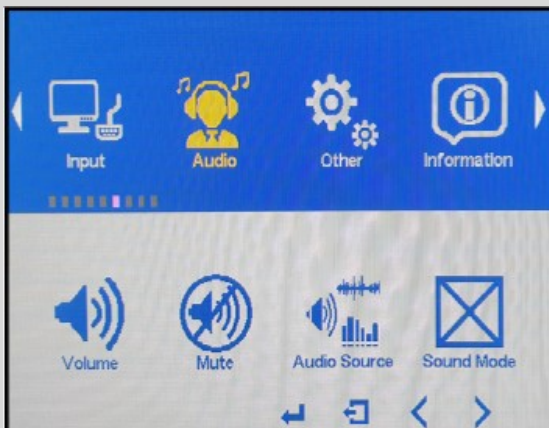

OSD Menü	Description
Volume	Adjust the sound volume (0~100)
Mute	Mute On/Off
Audio Source	Select the audio source (Analog / Digital)

Hotkey Function Definition

Key	Description
Down Key	Check input video information
Up Key	Select video input (Auto / DP / HDMI)



< Input Video Select >



< Input Video Select >

Operation and repairs

- Displaying a still image for a longer period of time can lead to image sticking problems (see our notes on the support area on the Internet at FAQ).
- Before opening the device, switch it off and disconnect it from the power supply.
- supply voltage.

The opening is to be carried out only by authorized technical personnel!

- Please note that high residual voltages may still be present in the device even after the supply voltage has been switched off or the mains plug has been disconnected. Unintentional contact with charged components and contacts can lead to electric shocks and damage to the device.
- Do not insert any objects into the device. Foreign objects of any kind inserted through the housing can lead to operational safety hazards and cause damage to the device and to persons.
- Do not spill any liquids inside. If this should happen, however, disconnect the device from the power supply immediately. There is a risk of fire if operation continues.
- Only install system extensions that are compatible with your system. Other extensions may damage the device or change the EMV behavior.
- **Important:**
If additional components or other modifications are subsequently installed on the device, the declaration of conformity within the scope of the CE marking is invalid and the operator is responsible for any problems that may occur.
- Stop operating the unit immediately if you notice anything abnormal, such as smoke, noise or odor. Disconnect the power plug and clarify the cause of the malfunction before operating again.

Cleaning

- Disconnect the device from the supply voltage before cleaning. Normally, cleaning with a dry cloth is sufficient. If the system unit is more heavily soiled, it can be cleaned with a damp cloth and a mild cleaning agent (CRTs only). No liquid should be allowed to enter the interior of the unit (open unit).
- The use of scouring powder and plastic-dissolving cleaning agents is strictly prohibited.
- The interior may only be cleaned by the service technician.
- Before commissioning, the device must be completely dry (risk of short circuit, fire).
- As the surface of LCDs is very soft and easy to scratch, please use a soft dry cloth for cleaning and do not use any chemical cleaning agents!
- The torque of the fixing screws on LCD panels should never exceed 0.39 Nm.
- Please never expose the surface of the LCD to impact or friction! If this happens, damage or scratch marks may remain on the surface.

Correct disposal of this product. (Electrical waste) Europe only.



To be used in the countries of the European Union and other European countries with a separate collection system.

The marking on the product or on the accompanying literature indicates that it must not be disposed of with other household waste at the end of its working life. Please dispose of this device separately from other waste to avoid harming the environment or human health through uncontrolled waste disposal. Recycle the device to promote sustainable recycling of material resources.

Private users should contact the dealer from whom the product was purchased or the relevant authorities to find out how to recycle the device in an environmentally friendly manner.

Commercial users should contact their supplier and consult the terms of the sales contract. This product must not be disposed of with other commercial waste.

DANGER: Explosion hazard–

The flat panel monitor is not intended for operation in potentially explosive atmospheres.

CAUTION: Equipment damage –

The flat panel monitor must be mounted without twisting. This also applies to mounting brackets.

No pressure may be exerted on the LCD panel during mounting and operation. This must be ensured by using a suitable mounting device.

So-called OEM monitors (OM-FLAT) must be mounted in such a way that no pressure is exerted on the LCD panel even after mounting. For this reason, in versions with a glued-on rubber strip, this must not be compressed by more than 0.2 mm.

The normal mounting position is vertical. A maximum tilt angle of 45° must not be exceeded.

EMV and equipment safety

Compliance with standards and guidelines

Certification that the industrial monitors/computers have been designed, manufactured and tested in accordance with the following guidelines established by the Council of the European Community:

2014/35/EU und 2014/30/EU

<p>Applied standards: Applied standards: Normes appliquées:</p>	<ul style="list-style-type: none"> • DIN EN 62368-1:2020 + A11:2020 • DIN EN 55022/AC:2011 • DIN EN 61000-6-2:2005/AC:2005
--	---

EMV tests were performed with standard cables of cable lengths up to 2.5 meters. If longer cables are used, then more extensive tests may be required to demonstrate compliance with the EMC Directive.

93/68/EWG (CE- Marking)



EN 62368-1 Security

Only devices that comply with the EN 62368 standard may be connected to the existing interfaces. Care must be taken to ensure appropriate "safe electrical isolation" from all other devices / data buses.

Appendix

Pin assignment VGA

15-pol. HD-Sub Mini DIN

Pin	Signal
1	Red
2	Green
3	Blue
4	GND
5	GND
6	GND
7	GND
8	GND
9	Nc
10	GND
11	Nc
12	DDC Data / SDA
13	H-SYNC
14	V-SYNC
15	DDC Clock

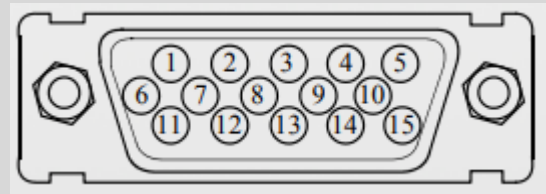

DVI D24P

DVI-D

Dual Link

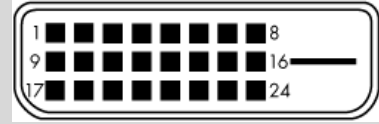

DVI - Videointerface

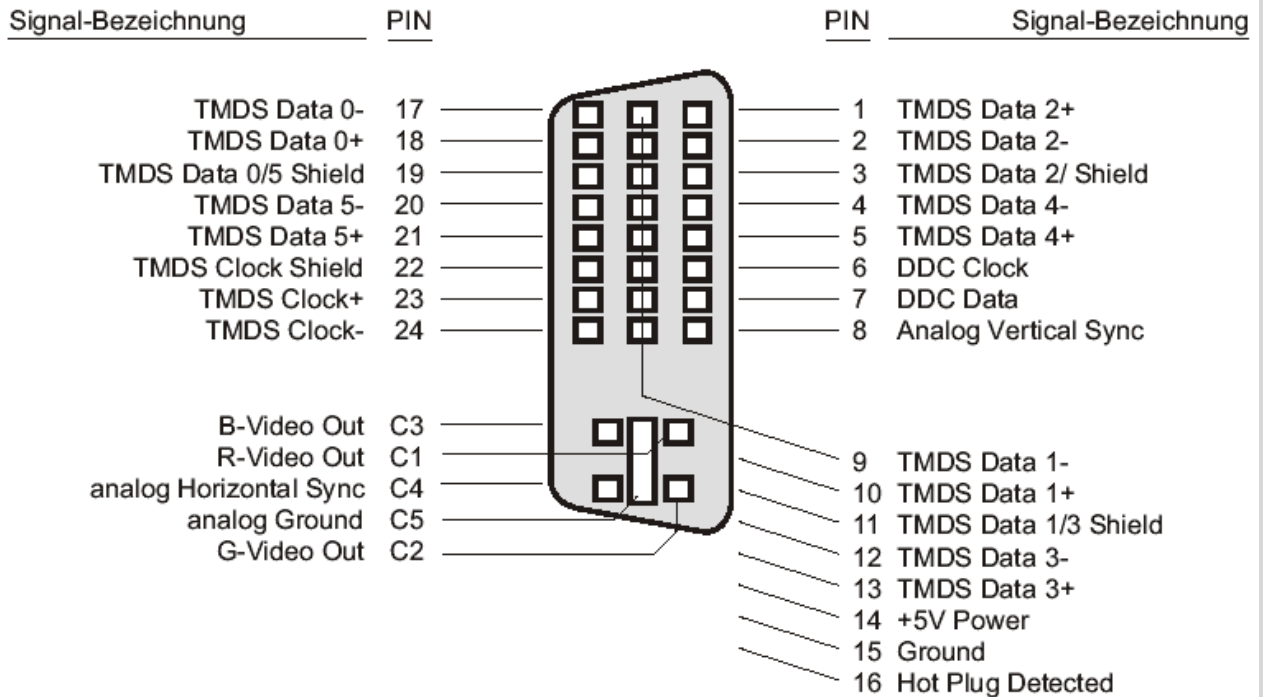

HDMI D24P

max. 10 m line length

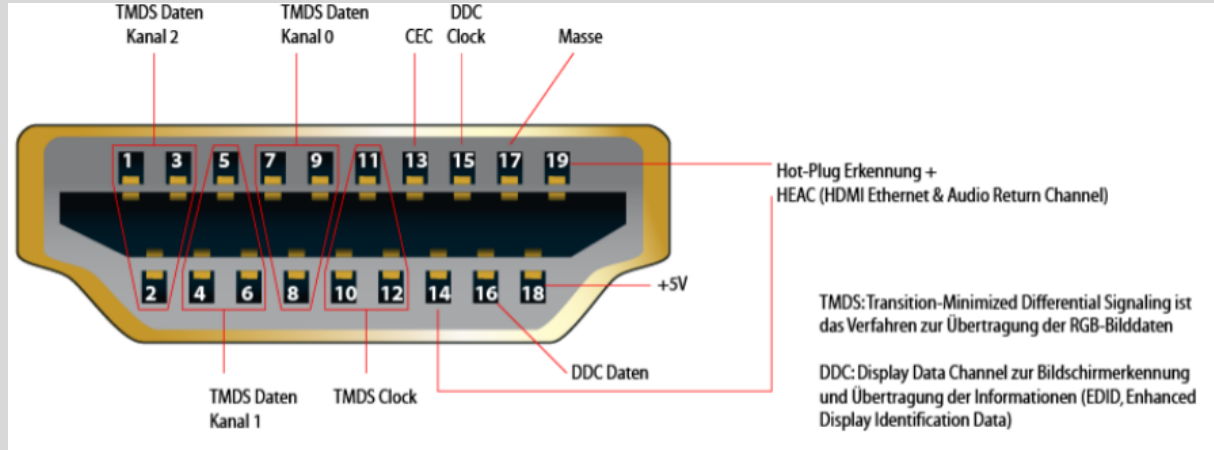

DisplayPort DP

max. 3 m line length

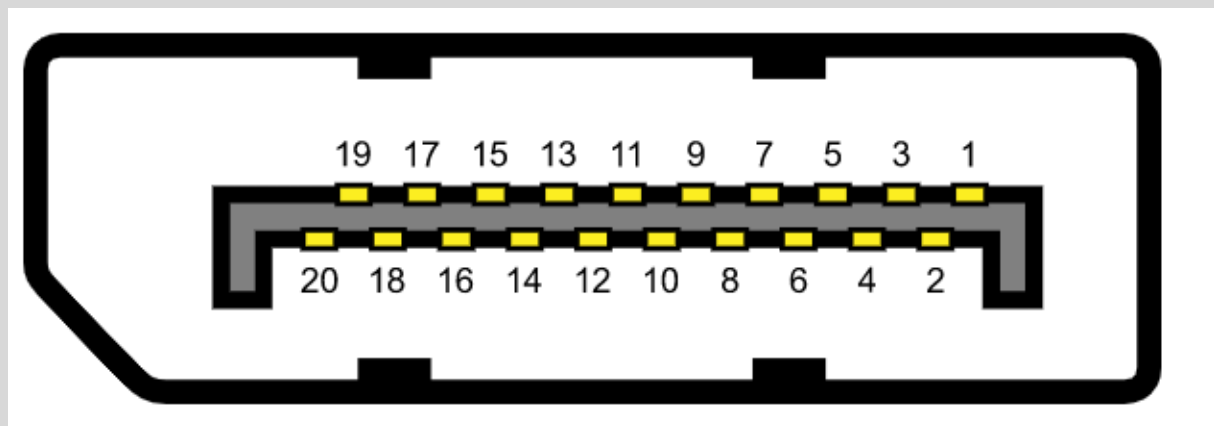

Pin	Funktion
1	LVDS – Leitung 0+
3	LVDS – Leitung 0-
5	Masse
7	LVDS – Leitung 2+
9	LVDS – Leitung 2-
11	Masse
13	Config 1
15	AUX-Kanal+
17	AUX-Kanal-
19	Stromversorgung: Masse

Pin	Funktion
2	Masse
4	LVDS – Leitung 1+
6	LVDS – Leitung 1-
8	Masse
10	LVDS – Leitung 3+
12	LVDS – Leitung 3-
14	Config 2
16	Masse
18	Hot-Plug-Erkennung
20	Stromversorgung: +3,3 V/0,5 A

AC supply

100 – 240 V~ AC

IEC Cold appliance socket



DC- Plug 12 / 24 V

Phoenix

MSTB 2,5 / 2-STF-5,08



Grounding bolt

Low-voltage ground, functional ground.

For proper function especially in connection with a capacitive touch.

